

SEQUENCE® Titan

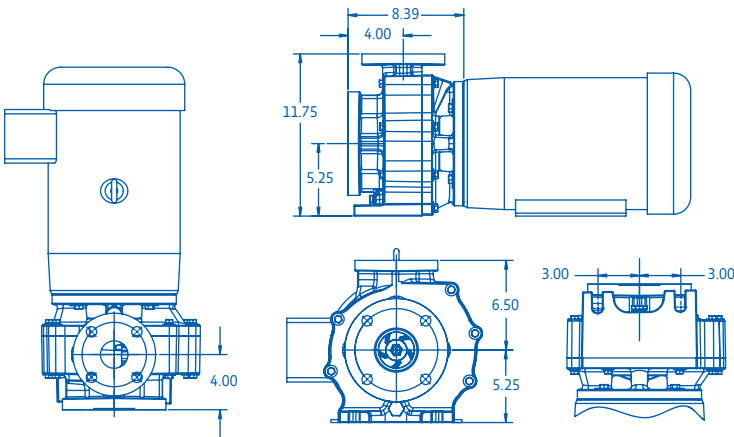

■ Titan Model 18000SEQ45

As large water features and high turnover requirements continue to gain popularity, the cost of energy does not! Introducing the Sequence® Titan series: Imagine 12,000 GPH for less than 845 watts! THE HIGHEST EFFICIENCY PUMPS available for water garden applications – where you need them most, in high flow! With flow rates between 12,000 and 32,000 GPH and head capabilities between 21 and 180 feet, the Sequence® Titan series is sure to cover most large scale water feature requirements. Sequence® Titan. Sequence® EFFICIENCY. It's the name of the game. **Available in 115 and 230 VAC. Cordset not provided. Made in the USA.**



*Dimensions and illustrations are approximate and for reference only

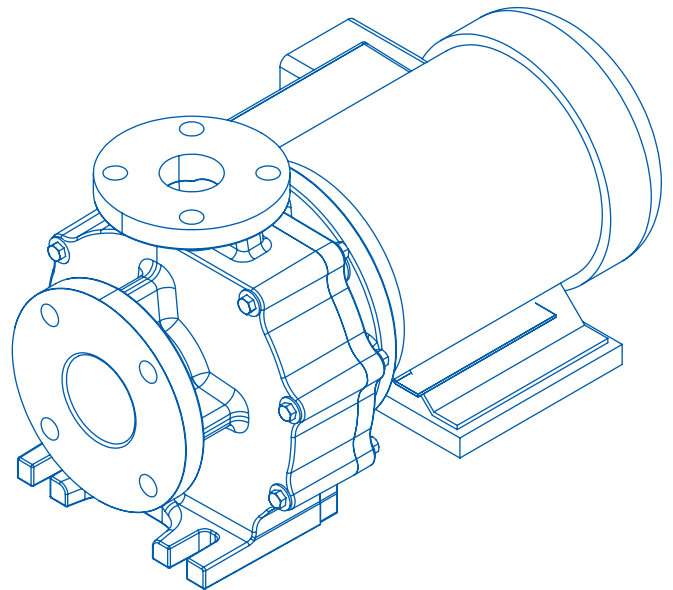

Flow At Total Dynamic Head

Model	Max Flow GPH	Max Head Feet	Max Power Watts	Max Current Amps	Flow At Total Dynamic Head					Voltage	Motor Enclosure	
					Flow	10'	20'	30'	40'			45'
18000SEQ45	18400	45	2315	12.0	GPM	275	238	192	125	60	230	TEFC
					GPH	16500	14280	11520	7500	3600		

Sustainable, Efficient

© 2009 SEQUENCE PUMPS A DIVISION OF MDM INC.



SEQUENCE 18000SEQ45

