

SEQUENCE® 4000

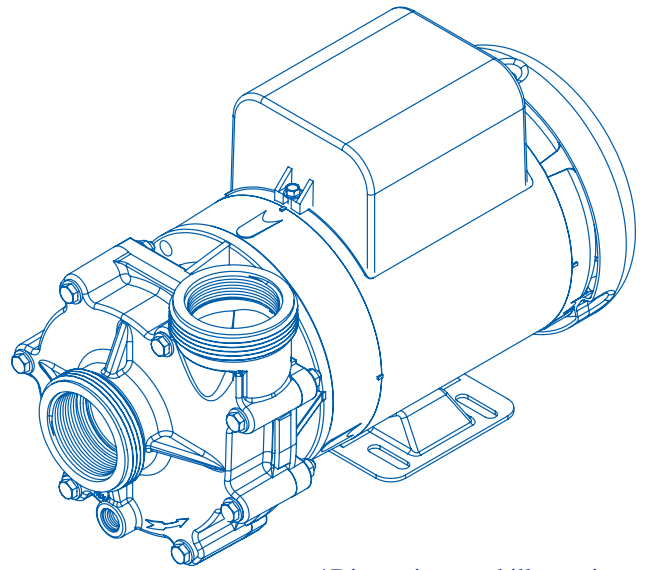

■ 4000 Model 3600SEQ20

Introducing the NEW Sequence® 4000. The new expansive design will meet today's increased market demand for performance on all levels. Peak performance of 3600 Gallons Per Hour while only requiring 207 Watts! Every Sequence® 4000 model is supplied complete with 2" FNPT and buttress thread ports and unions for ease of use. 3 year limited warranty. Made in USA. **Supplied with an 8-foot, 115V cordset.**

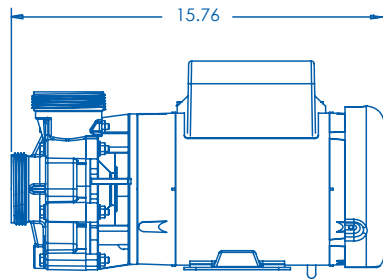
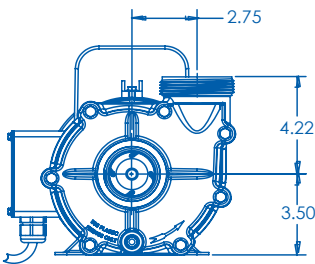

*Dimensions and illustrations are approximate and for reference only

Flow At Total Dynamic Head

Model	Max Flow GPH	Max Head Feet	Max Power Watts	Max Current Amps	Flow At Total Dynamic Head					Voltage	Motor Enclosure	
					Flow	4'	8'	12'	16'			18'
3600SEQ20	3600	20	207	2.3	GPM	53	45	36	23	13	115	TEFC
					GPH	3200	2700	2150	1400	800		

Sustainable, Efficient

© 2009 SEQUENCE PUMPS A DIVISION OF MDM INC.



 SEQUENCE 3600SEQ20

