

SEQUENCE® Power 1000

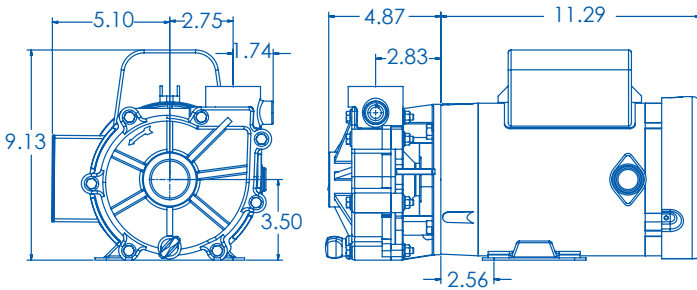

■ Power 1000 Model 9200PWR69

Massive flow! For the application that demands high performance, we offer the Sequence® Power 1000 Series with abundant flow and pressure. The Power 1000 puts the horsepower and efficiency into the pressure side of the performance requirement but maintains flow rates that will meet the most challenging of scenarios. Motor is totally-enclosed, fan-cooled for durability. 115V or 230 volt. 3 year limited warranty. Made in USA. **Supplied with an 8-foot, 230V cordset.**



*Dimensions and illustrations are approximate and for reference only

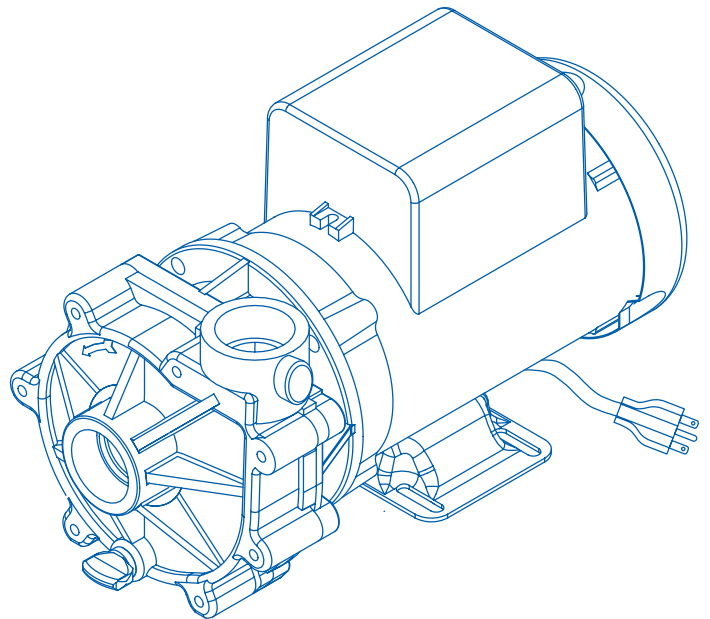

Flow At Total Dynamic Head

Model	Max Flow GPH	Max Head Feet	Max Power Watts	Max Current Amps	Flow					Voltage	Motor Enclosure	
					10'	20'	30'	40'	50'			
9200PWR69	9200	69	1744	6.82	GPM	143	130	117	100	81	230	TEFC
					GPH	8580	7800	7020	6000	4860		

Sustainable, Efficient

© 2009 SEQUENCE PUMPS A DIVISION OF MDM INC.



SEQUENCE 9200PWR69 (High-Speed)

